

txc wireless transmitters



The TXC series of hand-held Wireless Transmitters are available in a wide range of style — all featuring simplified operation with a focus on personal, practical control.

TXC transmitters are available in 4-button, 16-button, and 32-button models. Each is a versatile performer, able to transmit 1-way wireless commands in RF and IR formats.

Employing a standard button configuration, each can be fully personalized by deleting buttons, changing button colors, and adding customized text and graphic engraving.



txc wireless transmitters

TXC4+ (FG5170-304, -310, -315, -418, -433)

4-BUTTON TRANSMITTER

- Provides up 4 buttons and 6 control functions (pressing each pair together transmits alternate control code)
- Finger trigger emulates pressing upper left button
- Includes custom engraving, button layout, and basic overlay color selection
- Transmits 1-way RF/IR wireless signals
- Black, gray, and white buttons available

RF FREQUENCY

418 MHz standard, others on request

75-foot range in typical applications

IR FREQUENCY

455 kHz or 38 kHz (switchable)

DIMENSIONS (HWD)

5.38" x 1.79" x 1.46" (13.67 cm x 4.55 cm x 3.71 cm)

WEIGHT

3.1 oz (88 g)

POWER

Two AAA-size 1.5 V alkaline batteries (included)

TXC16+ (FG144-304, -310, -315, -407, -418, -433)

16-BUTTON TRANSMITTER

- Provides up 16 control buttons
- Includes custom engraving, button layout, and basic overlay color selection
- Transmits 1-way RF/IR wireless signals
- Black, gray, and white buttons available

RF FREQUENCY

418 MHz standard, others on request

75-foot range in typical applications

IR FREQUENCY

455 kHz or 38 kHz (switchable)

DIMENSIONS (HWD)

5.250" x 2.875" x 0.750"
(13.34 cm x 7.30 cm x 1.91 cm)

WEIGHT

4.1 oz (116.6 g)

POWER

Two N-size 1.5 V alkaline batteries (included)

TXC32+ (FG145-304, -310, -315, -407, -418, -433)

32-BUTTON TRANSMITTER

- Provides up 32 control buttons; optional 48-button layout for creative design solutions and keypad layouts
- Includes custom engraving, button layout, and basic overlay color selection
- Transmits 1-way RF/IR wireless signals
- Black, gray, and white buttons available

RF FREQUENCY

418 MHz standard, others on request

75-foot range in typical applications

IR FREQUENCY

455 kHz or 38 kHz (switchable)

DIMENSIONS (HWD)

5.250" x 6.250" x 0.750"
(13.34 cm x 15.87 cm x 1.91 cm)

WEIGHT

8.6 oz (245.5 g)

POWER

Four N-size 1.5 V alkaline batteries (included)

TXC4L+ (FG5171-304, -310, -315, -418)

4-BUTTON TRANSMITTER WITH LASER POINTER

- Includes integral laser pointer
- Finger trigger activates laser pointer

WEIGHT

3.3 oz (94 g)

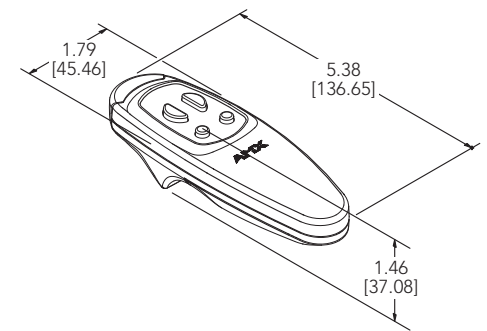

TXC4+/TXC4L+

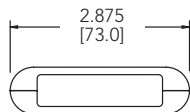

TXC16+ (Top)

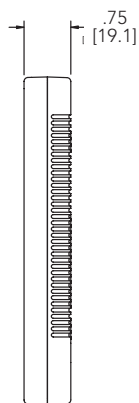

TXC16+ (Right Side)

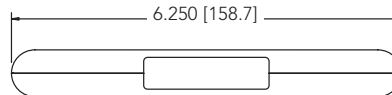

TXC32+ (Top)

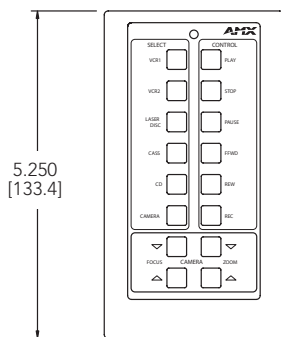

TXC16+ (Front, with engraved overlay)

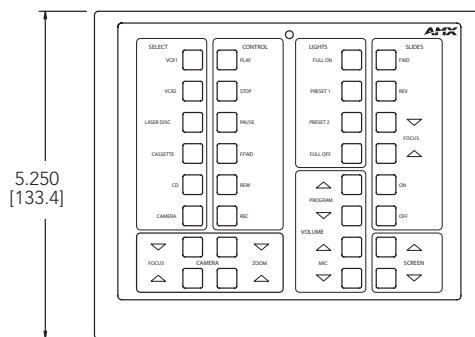

TXC32+ (Front, with engraved overlay)

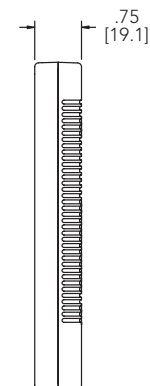

TXC32+ (Right Side)



IT'S YOUR WORLD. TAKE CONTROL.

ARGENTINA • AUSTRALIA • BELGIUM • BRAZIL • CANADA • CHINA • ENGLAND • FRANCE • GERMANY • GREECE • HONG KONG • INDIA • INDONESIA • ITALY • JAPAN
LEBANON • MALAYSIA • MEXICO • NETHERLANDS • NEW ZEALAND • PHILIPPINES • PORTUGAL • RUSSIA • SINGAPORE • SPAIN • SWITZERLAND • THAILAND • TURKEY • USA
ATLANTA • BOSTON • CHICAGO • CLEVELAND • DALLAS • DENVER • INDIANAPOLIS • LOS ANGELES • MINNEAPOLIS • PHILADELPHIA • PHOENIX • PORTLAND • SPOKANE • TAMPA
3000 RESEARCH DRIVE, RICHARDSON, TX 75082 • 800.222.0193 • 469.624.8000 • +1.469.624.7400 • 469.624.7153 fax • www.amx.com